



The Art of Lifestyle
designed in Germany



POPART

2025 • 2026

INHALT

CONTENT

CONTENU

- 4** Romero Britto
- 20** Ed Heck
- 26** Billy the Artist
- 32** Mauro Bergonzoli
- 38** James Rizzi
- 52** Präsentationsvorschlag • Suggestion for decoration • Proposition de décoration
- 53** Werbemittel • Advertising Material • Matériel PLV
- 54** Produktinformationen • Product informations • Informations sur la fabrication

NEW



RIZZIS KAKTEEN

RIZZI'S CACTI • LES CACTUS DE RIZZI

Rizzis Kakteen sind Beispiele für seinen ausgeprägten Sinn für Humor. Die stacheligen Gesellen mit den lustigen Gesichtern leben von ihren witzigen Details. Perfekte Mitbewohner für alle, die ihre Wohnung mit einem Augenzwinkern dekorieren möchten.

Rizzi's cacti are examples of his pronounced sense of humor. The spiky fellows with the funny faces live from their witty details. Perfect roommates for all those who want to decorate their home with a wink.

Les cactus de Rizzi sont des exemples de son sens de l'humour. Ces compagnons épineux aux visages amusants prennent vie grâce à leurs détails amusants. Des colocataires parfaits pour tous ceux qui souhaitent décorer leur intérieur avec un clin d'œil.

ab Seite/Page 38



POP ART

LAUT. BUNT. INTERNATIONAL.

Im Februar 2011 begann mit Romero Britto die Erfolgsgeschichte der Pop Art bei Goebel. Immer wieder begeistert Goebel aktuelle Künstler für den Werkstoff Porzellan. Die Umsetzung der Motive erfolgt ab dem ersten Entwurf in enger Zusammenarbeit mit dem Künstler, um dessen einzigartigen Stil zu erhalten. Durch diese intensive Kooperation werden Objekte aus handwerklicher Perfektion geschaffen.

In February 2011 Goebel successfully entered the world of Pop Art with the launch of the Romero Britto range. Ever since, Goebel succeeded in enthusing contemporary artists to work with Porcelain and glass. Great paintings and daring designs become objects of perfect craftsmanship. The transformation of the Pop Art motives onto Porcelain and glass is done in close cooperation with the artists to bring out the best of their unique style. Enjoy a genuine work of art in your home.

Goebel a entamé le projet Pop Art en février 2011, avec le lancement de la première collection signée Romero Britto. Depuis ce temps, Goebel a réussi à motiver des artistes contemporains à travailler avec les matériaux de Porcelaine et verre. En étroite collaboration avec ces artistes, et en respectant parfaitement leurs styles uniques, Goebel fait transposer et interpréter les motifs des tableaux et dessins par ses maîtres Porcelainiers et verriers. Nous vous invitons à l'univers Pop Art signé Goebel.



ROMERO BRITTO



KRÄFTIG & LEUCHTEND

Pop Art Künstler Romero Britto benutzt leuchtende Farben und kräftige Muster als visuelle Sprache der Hoffnung und des Glücks. Er stellte im Louvre aus und präsentierte die größte öffentliche Ausstellung von Kunstobjekten in der Geschichte des Hyde Parks - eine Kunst, die allen gefällt!

Pop Artist Romero Britto uses vibrant colours and bold patterns as a visual language of hope and happiness. He has been credited with the largest public art installation in Hyde Park history and exhibited at the Louvre Museum - an art that appeals to all!

L'artiste de Pop Art Romero Britto utilise des couleurs vibrantes et des motifs forts comme langage visuel traduisant l'espoir et la joie de vivre. Il a présenté la plus grande installation artistique dans l'histoire du Hyde Park et a pu exposer ses œuvres au Musée du Louvre - un art qui séduit chacun d'entre nous !

Cherries

Figur • Figurine • Objet décoratif

33 cm

25.024950.0.906.4 • VE1

66-453-32-1

 NEW  MDF 

4 005169 371974

 999
 LTD.
 EDT.

MDF mit MDF Sockel
with fiberboard base (MDF)
avec socle en fibres à densité moyenne (MDF)

Z mit Zertifikat
with certificate
avec certificat

SET Set
ensemble



Golden Great India II

Figur • Figurine • Objet décoratif
22 cm
25.013750.0.906.4 • VE1
66-453-34-1

NEW G P MDF



BRITTO™



Liberty

Figur • Figurine
Objet décoratif
70 cm
25.099950.0.906.4 • VE1
66-453-31-1

NEW P MDF Z



199
LTD.
EDT.



Golden All We need is Love

Sektgläser • Champagne glasses
Flûtes à champagne
24 cm • 0,1l
25.004950.0.906.4 • VE1
66-453-37-1

NEW G G SET





ROMERO BRITTO



499
LTD.
EDT.

Golden Cheek to Cheek

Figur • Figurine • Objet décoratif

47 cm

20.039950.0.906.1 • VE1

66-452-50-1

P G MDF Z



Golden Hug Too

Figur • Figurine • Objet décoratif

47 cm

19.039950.0.906.1 • VE1

66-452-40-1

P G MDF Z



499
LTD.
EDT.



Golden Big Apple

Figur • Figurine • Objet décoratif

18 cm

24.007950.0.906.1 • VE1

66-453-30-1

P G MDF



499
LTD.
EDT.

Golden Big Apple

Figur • Figurine • Objet décoratif

40 cm

21.034950.0.906.1 • VE1

66-452-72-1

P G MDF Z





999
LTD.
EDT.

Faith

Figur • Figurine • Objet décoratif
38 cm
19.029950.0.906.7 • VE1
66-452-22-1



Golden Faith

Figur • Figurine • Objet décoratif
23 cm
24.014950.0.906.1 • VE1
66-453-29-1



Big Apple

Figur • Figurine • Objet décoratif
17 cm
17.006950.0.906.1 • VE1
66-451-95-1



499
LTD.
EDT.

Big Apple

Figur • Figurine • Objet décoratif
58 cm
17.075000.0.906.1 • VE1
66-451-79-1



BRITTO™





ROMERO BRITTO



Golden Deeply in Love I

Figur • Figurine • Objet décoratif
28,5 cm
25.005950.0.906.4 • VE1
66-453-35-1

NEW G P



4 005169 372001



Golden Deeply in Love II

Figur • Figurine • Objet décoratif
28 cm
25.005950.0.906.4 • VE1
66-453-36-1

NEW G P



4 005169 372018



999
LTD.
EDT.

Golden Ginger

Figur • Figurine • Objet
décoratif 30 cm
25.029950.0.906.4 • VE1
66-453-33-1

NEW P MDF Z



4 005169 371981



499

LTD.
EDT.

Golden Follow Me

Figur • Figurine • Objet décoratif
41 cm
24.044950.0.906.1 • VE1
66-453-27-1

P G MDF Z



4 005169 367007



ROMERO BRITTO



Hug Too

Figur • Figurine • Objet décoratif
15,5 cm
17.004950.0.906.1 • VE 1
66-451-89-1

P MDF Z



499
LTD.
EDT.

Hug Boy

Figur • Figurine • Objet décoratif
47 cm
24.039950.0.906.1 • VE 1
66-453-26-1

P MDF Z



499
LTD.
EDT.

My Lovely Friend

Figur • Figurine • Objet décoratif
47 cm
23.039950.0.906.1 • VE 1
66-453-15-1

P MDF Z



499
LTD.
EDT.

Dancing Boy

Figur • Figurine • Objet décoratif
47,5 cm
23.039950.0.906.1 • VE 1
66-453-14-1

P MDF Z





499
LTD.
EDT.

Pet's Love

Figur • Figurine • Objet décoratif
47 cm
21.039950.0.906.7 • VE1
66-452-73-1

P MDF Z



4 005169 349416



499
LTD.
EDT.

Swing

Figur • Figurine • Objet décoratif
46 cm
17.049950.0.906.7 • VE1
66-451-77-1

P MDF Z



4 005169 300820



199
LTD.
EDT.

Tonight

Figur • Figurine • Objet décoratif
68 cm
18.125000.0.906.1 • VE1
66-451-78-1

P MDF Z



4 005169 300837



1.000
LTD.
EDT.

Follow Me

Figur • Figurine • Objet décoratif
41 cm
13.044950.0.906.1 • VE1
66-450-80-0

P MDF Z



4 005169 273179



ROMERO BRITTO



Swing

Figur • Figurine • Objet décoratif
24,5 cm
22.019950.0.906.7 • VE1
66-452-76-1



Cheek to Cheek

Figur • Figurine • Objet décoratif
23,5 cm
18.019950.0.906.1 • VE1
66-452-06-1



Children of the World

Figur • Figurine • Objet décoratif
14 cm
24.012450.0.906.1 • VE1
66-453-25-1



Love Blossoms

Figur • Figurine • Objet décoratif
56 cm
20.090000.0.906.1 • VE1
66-452-55-1



199
LTD.
EDT.





999
LTD.
EDT.

Golden Cat

Figur • Figurine • Objet décoratif

31 cm

24.024950.0.906.1 • VE1

66-453-28-1

P G MDF Z



4 005169 367014



999
LTD.
EDT.

Soul Mates

Figur • Figurine • Objet décoratif

21,5 cm

16.024950.0.906.1 • VE1

66-451-72-1

P MDF Z



4 005169 299032



1.000
LTD. EDT.

Blue Cat

Figur • Figurine • Objet décoratif

31 cm

14.024950.0.906.1 • VE1

66-451-03-0

P MDF Z



4 005169 282775



ROMERO BRITTO



Coco

Figur • Figurine • Objet décoratif
13,5 cm
18.004950.0.906.1 • VE1
66-452-11-1

P MDF



Flowing

Figur • Figurine • Objet décoratif
14,5 cm
20.004950.0.906.1 • VE1
66-452-59-1

P MDF



Baby Blue

Figur • Figurine • Objet décoratif
15,5 cm
20.004950.0.906.1 • VE1
66-452-58-1

P MDF



Flying Cow

Figur • Figurine • Objet décoratif
19 cm
22.011450.0.906.1 • VE1
66-453-10-1

P MDF Z



999
LTD.
EDT.

Flying Cow

Figur • Figurine • Objet décoratif
31 cm
23.024950.0.906.1 • VE1
66-453-16-1

P MDF Z





Spring Elephant

Figur • Figurine • Objet décoratif
13,5 cm
15.004950.0.906.1 • VE1
66-451-45-3

P MDF



4 005169 289545



Spring Elephant

Figur • Figurine • Objet décoratif
33,5 cm
20.024950.0.906.1 • VE1
66-452-56-1

P G MDF Z



4 005169 337000

999

LTD.
EDT.



Prince

Figur • Figurine • Objet décoratif
14,5 cm
18.004950.0.906.1 • VE1
66-452-10-1

P G MDF



4 005169 311734



Truly Yours

Figur • Figurine • Objet décoratif
12,5 cm
15.004950.0.906.1 • VE1
66-451-46-1

P MDF



4 005169 289552



Truly Yours

Figur • Figurine • Objet décoratif
30 cm
15.024950.0.906.1 • VE1
66-451-47-9

P MDF Z



4 005169 289569

1.000

LTD. EDT.



Great India 3

Figur • Figurine • Objet décoratif
17 cm
18.009450.0.906.1 • VE1
66-452-09-1

P MDF



4 005169 311727



ROMERO BRITTO



Golden Spring Elephant
Figur • Figurine • Objet décoratif
14 cm
19.006450.0.906.1 • VE1
66-452-49-1

P G MDF



Golden Truly Yours
Figur • Figurine • Objet décoratif
12,5 cm
19.006450.0.906.1 • VE1
66-452-48-1

P G MDF



Golden Truly Yours
Figur • Figurine • Objet décoratif
30 cm
20.024950.0.906.1 • VE1
66-452-51-1

P G MDF Z



999
LTD.
EDT.



Golden Prince
Figur • Figurine • Objet décoratif
14,5 cm
23.006450.0.906.1 • VE1
66-453-18-1

P G MDF



Golden Great India
Figur • Figurine • Objet décoratif
29 cm
18.024950.0.906.1 • VE1
66-452-20-1

P G MDF Z



999
LTD.
EDT.



Golden Dancer
Figur • Figurine • Objet décoratif
31 cm
23.029950.0.906.1 • VE1
66-453-17-1

P G MDF Z



999
LTD.
EDT.



Deeply in Love 1

Figur • Figurine • Objet décoratif
29 cm
13.004950.0.906.1 • VE1
66-450-91-7



Deeply in Love 2

Figur • Figurine • Objet décoratif
29 cm
13.004950.0.906.1 • VE1
66-450-92-5



999
LTD.
EDT.



Ocean Love

Figur • Figurine • Objet décoratif
31 cm
21.024950.0.906.1 • VE1
66-452-75-1



Golden All We Need is Love

Vase
30 cm
24.009950.0.906.7 • VE1
66-453-24-1



Golden All We Need is Love

Vase
20 cm
24.005950.0.906.7 • VE1
66-453-23-1





ROMERO BRITTO



New Life

Figur • Figurine • Objet décoratif
35,5 cm
23.007450.0.906.1 • VE1
66-452-57-1



Falling

Vase
30 cm
23.009950.0.906.7 • VE1
66-453-19-1



In Love

Vase
20 cm
23.005950.0.906.11 • VE1
66-453-20-1



A New Day

Wanduhr • Clock • Horloge
ø 31 cm
23.007450.0.906.7 • VE1
66-453-21-1



A New Day

Teetasse mit Deckel und Sieb • Teacup with lid and strainer

Tasse pour thé avec couvercle et passe-thé

14 cm • 0,45 l

24.002125.0.906.7 • VE1

66-453-22-1



4 005169 366505



A New Day

Künstlertasse

Mug • Tasse

11 cm • 0,4 l

22.001500.0.906.1 • VE2

66-452-83-1



4 005169 349515



Britto Garden

Tea for One

15,5 cm • 0,35 l

20.002750.0.906.7 • VE1

66-452-71-1



4 005169 340710



A New Day

Espressotasse • Espresso cup

Tasse à espresso

7 cm • 0,1 l

22.001750.0.906.1 • VE2

66-452-87-1



4 005169 349553



All We Need is Love

Espressotasse • Espresso cup

Tasse à espresso

7 cm • 0,1 l

22.001750.0.906.1 • VE2

66-452-88-1



4 005169 349560



All We Need is Love

Künstlertasse • Mug • Tasse

11 cm • 0,4 l

22.001500.0.906.1 • VE2

66-452-84-1



4 005169 349522

LIFE CAN BE FUN.

Der amerikanische Künstler lebt und arbeitet in Brooklyn, New York. Nach dem Kunststudium arbeitete er zunächst als Illustrator für das American Museum of Natural History. Dann begann er seine eigenen Dinosaurier und Figuren zu gestalten. Ed Heck entwickelte seine Kunst aus seiner Leidenschaft für Musik und für die prähistorische Tierwelt. Sein Lebensstil, unprätentiös und schlicht, entspricht auch seinem Malstil, der sich durch eine Reduktion auf das Wesentliche, gewürzt mit einem Schuss pfeffrigen Humor, auszeichnet. Sein Markenzeichen ist die zittrige schwarze Umrisslinie, „Life can be fun“ ist die Devise.

The American artist lives and works in Brooklyn, New York. After studying art, he first worked as an illustrator for the American Museum of Natural History. Then he began to create his own dinosaurs and other characters. Ed Heck

developed his art from his passion for music and prehistoric animals. His unpretentious and simple lifestyle also corresponds to his painting style, which is characterised by a reduction to the essential, spiced with a dash of smart humour. His trademark is the shaky black outline, „Life can be fun“ is his motto.

L'artiste américain vit et travaille à Brooklyn, New York. Après des études d'arts, il a tout d'abord travaillé comme illustrateur pour le musée américain d'histoire naturelle. Il a ensuite commencé à créer ses propres dinosaures et figurines. Ed Heck a développé son art à partir de sa passion pour la musique et la faune préhistorique. Son style de vie, simple et sans prétention, correspond également à son style de peinture: réduit à l'essentiel, avec une pointe d'humour. Sa marque de fabrique est la ligne de contour noire tremblante, life can be fun est sa devise.



When Pigs Fly

Figur • Figurine • Objet décoratif

19,5 cm

25.005950.0.538.4 • VE1

67-200-17-1

NEW   

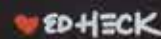

4 005169 371820

 ED HECK



ED HECK



Liberty Dog
 Figur • Figurine • Objet décoratif
 26,5 cm
 24.011250.0.538.1 • VE1
 67-200-01-1

(P) MDF



4 005169 367687



Roar
 Figur • Figurine • Objet
 décoratif
 14 cm
 25.004950.0.538.4 • VE1
 67-200-16-1

NEW (P) MDF



4 005169 371813



Rock On
 Figur • Figurine • Objet décoratif
 18,5 cm
 24.004950.0.538.1 • VE1
 67-200-02-1

(P) MDF



4 005169 367694



Love Cat
 Figur • Figurine • Objet décoratif
 12,5 cm
 24.004950.0.538.1 • VE1
 67-200-03-1

(P) MDF



4 005169 367700



ED HECK



Rock On

Teetasse mit Deckel und Sieb
Teacup with lid and strainer
Tasse pour thé avec
couvercle et passe-thé
14 cm • 0,45 l
24.002125.0.538.7 • VE 1
67-200-13-1



Love Dog

Künstlertasse • Mug • Tasse
11 cm • 0,4 l
24.001500.0.538.1 • VE 2
67-200-09-1



Love Cat

Künstlertasse • Mug • Tasse
11 cm • 0,4 l
24.001500.0.538.1 • VE 2
67-200-10-1



Love Dog

Espressotasse • Espresso cup
Tasse à expresso
7,5 cm • 0,1 l
24.001750.0.538.1 • VE 2
67-200-11-1



Love Cat

Espressotasse • Espresso cup
Tasse à expresso
7,5 cm • 0,1 l
24.001750.0.538.1 • VE 2
67-200-12-1





When Pigs Fly

Künstlertasse • Mug • Tasse
 11 cm • 0,4 l
 25.001500.0.538.4 • VE2
 67-200-18-1

NEW F ●



4 005169 371837



Roar

Künstlertasse • Mug • Tasse
 11 cm • 0,4 l
 25.001500.0.538.4 • VE2
 67-200-19-1

NEW F ●



4 005169 371844



Roar

Espressotasse • Espresso Cup
 Tasse à Espresso
 6,5 cm • 0,1 l
 25.001750.0.538.4 • VE2
 67-200-21-1

NEW F ●



4 005169 371868



When Pigs Fly

Espressotasse • Espresso Cup
 Tasse à Espresso
 6,5 cm • 0,1 l
 25.001750.0.538.4 • VE2
 67-200-20-1

NEW F ●



4 005169 371851



Love Dog

Künstlerdose • Box • Boîte
 11 cm • 0,6 l
 25.000500.0.538.4 • VE1
 67-200-22-1

NEW M



4 005169 371875



ED HECK



My New York City

Einkaufstasche • Shopping Bag

Sac à courses

37 x 12 x 33,5 cm

25.000250.0.538.4 • VE1

67-200-23-1

NEW **K**



4 005169 371882



Rock On

Wanduhr • Clock • Horloge

30 x 30 cm

24.007450.0.538.1 • VE1

67-200-15-1

H **M**



4 005169 371165



Little Angles

Stockschirm mit Upside-Down-Öffnung

Umbrella with upside down opening

Parapluie à ouverture inversée

80 cm x Ø 108 cm

25.002000.0.538.4 • VE1

67-200-24-1

NEW **M** **K**



4 005169 372193

Lookin' Cool

Brillenetui • Spectacle case • Étui à lunettes
 16 x 6 x 4,5 cm
 mit Mikrofaser-Reinigungstuch
 with microfiber cleaning cloth
 avec chiffon en microfibres
 24.001000.0.538.1 • VE 2
 67-200-14-1

ST



4 005169 368622



Love Dog

Schlüsselanhänger
 Keychain • Porte-clés
 5 cm
 24.000500.0.538.1 • VE 10
 67-200-04-1

K M



4 005169 367717



Roar

Schlüsselanhänger
 Keychain • Porte-clés
 5 cm
 24.000500.0.538.1 • VE 10
 67-200-05-1

K M



4 005169 367724



Duck Gone Wild

Schlüsselanhänger
 Keychain • Porte-clés
 5 cm
 24.000500.0.538.1 • VE 10
 67-200-06-1

K M



4 005169 367731



When Pigs Fly

Schlüsselanhänger
 Keychain • Porte-clés
 5 cm
 24.000500.0.538.1 • VE 10
 67-200-07-1

K M



4 005169 367748

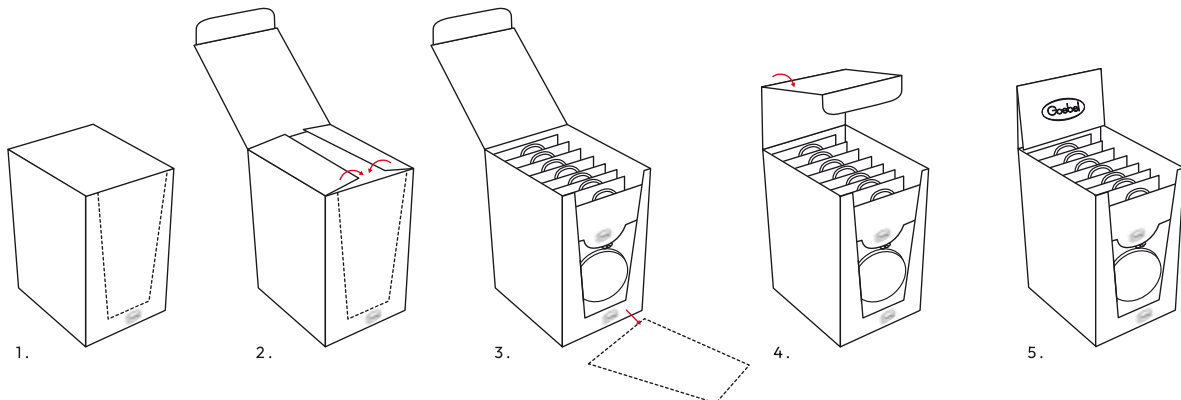

Verpackung als Display nutzbar • Packaging can be used as a Display • L'emballage à utiliser comme présentoir

POSITIVE ENERGIE

Billy the Artist, auch BTA genannt, war schon zu Lebzeiten ein international bekannter und erfolgreicher Künstler. Er arbeitete für viele große Weltmarken, unter anderem für Swatch und Nescafé. Geprägt durch seine Heimatstadt New York nannte er seine Kunst „urban primitive pop“. Sein Werk, eine puzzle-ähnliche Gestaltung aus Gesichtern, bloßen Augen und Formen, ist voller positiver Energie. Seine Live-Auftritte waren legendär und rund um den Globus anzutreffen. So konnten sich während der Vorstellung seiner Swatch Uhr auf der Piazza San Marco in Venedig 30.000 Zuschauer von seinem Ideenreichtum überzeugen. Entsprechend seinem Motto „I believe in creating your own reality“ bewahren wir den energievollen Ausdruck seiner Werke in unserer Kollektion.

Billy the Artist, also known as BTA, was a popular and successful international artist. He worked for many international brands such as Swatch and Nescafé. Characterized by his home town New York City he called his art „urban primitive pop“. His artwork is a puzzle-like creation of faces, merely eyes and forms combined to a source of positive energy. His live acts all around the world were legendary. 30.000 visitors came to the show at the piazza San Marco in Venice when BTA introduced his Swatch creation. According to his motto „I believe in creating your own reality“ we keep the energetic impact of his work in our collection.

Billy the Artist, également appelé BTA, était déjà de son vivant un artiste internationalement connu et couronné de succès. Il a travaillé pour de nombreuses grandes marques mondiales, dont Swatch et Nescafé. Marqué par sa ville, New York, il a appelé son art „urban primitive pop“. Son art : une création qui ressemble à un puzzle de visages, d'yeux nus et de formes. Ses œuvres sont pleines d'énergie positive. Ses représentations en direct étaient légendaires et se retrouvaient aux quatre coins du monde. Ainsi, lors de la présentation de sa montre Swatch sur la Piazza San Marco à Venise, 30 000 spectateurs ont pu se rendre compte de son inventivité. Conformément à sa devise „I believe in creating your own reality“, nous conservons l'expression énergétique de ses œuvres dans notre collection.



BILLY
THE ARTIST



499
LTD.
EDT.



BILLY THE ARTIST

Evolution of Love I

Vase
42 cm
24.026950.0.286.1 • VE1
67-080-79-1



PROPART



BILLY THE ARTIST

Evolution of Love

Figur • Figurine • Objet décoratif
22 x 8,5 x 15 cm
24.010950.0.286.1 • VE1
67-080-80-1

MDF



4 005169 366703



Evolution of Love

Figur • Figurine • Objet décoratif
38 x 12 x 26 cm
23.019950.0.286.1 • VE1
67-080-71-1

MDF Z



4 005169 358654



999
LTD.
EDT.

Celebration Sunrise

Figur • Figurine • Objet décoratif

18 cm

18.006450.0.286.1 • VE 1

67-080-26-1

P MDF



4 005169 315671

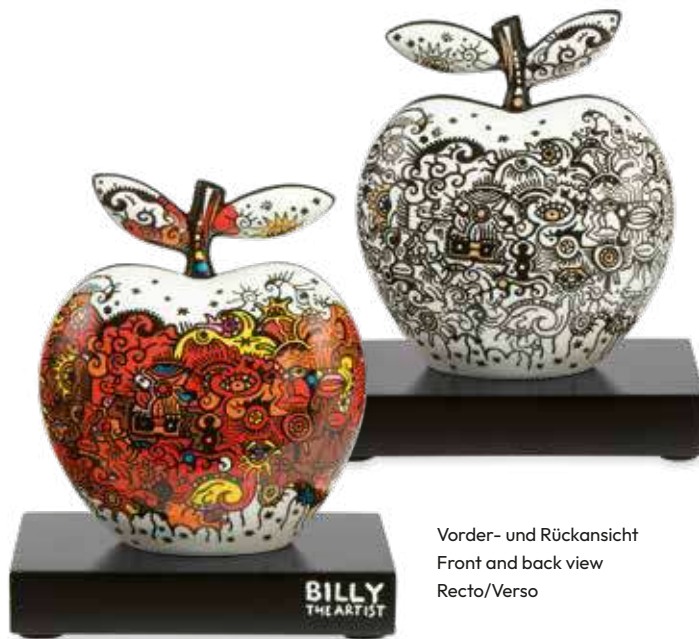

Vorder- und Rückansicht
Front and back view
Recto/Verso

Together/Two in One

Figur • Figurine • Objet décoratif

28 cm

20.014950.0.286.1 • VE 1

67-080-49-1

P MDF Z



4 005169 338717



999
LTD.
EDT.

Vorder- und Rückansicht
Front and back view
Recto/Verso



BILLY THE ARTIST



Evolution of Love II

Vase
24 cm
24.009450.0.286.1 • VE 1
67-080-78-1



4 005169 366680

KÜNSTLERTASSEN • MUGS • TASSES



Evolution of Love I

11 cm • 0,4 l
23001500.0.286.1 • VE 2
67-080-73-1



4 005169 362484



Evolution of Love II

11 cm • 0,4 l
23.001500.0.286.1 • VE 2
67-080-74-1



4 005169 362491

Evolution of Love

Einkaufstasche

Shopping bag

Sac de courses

37 x 12 x 33,5 cm

24.000250.0.286.7 • VE 10

67-080-81-1

K



4 005169 366710

mit Innentasche

with inner compartment

avec compartiment intérieur



ESPRESSOTASSEN • ESPRESSO CUPS • TASSES À EXPRESSO



Evolution of Love I

7 cm • 0,1l

23.001750.0.286.1 • VE 2

67-080-75-1

F



4 005169 362507



Evolution of Love II

7 cm • 0,1l

23.001750.0.286.1 • VE 2

67-080-76-1

F



4 005169 362514



MAURO BERGONZOLI



MAGIC!

KRAFTVOLLE BUNTHEIT.

Den italienischen Künstler Mauro Bergonzoli kennt man vor allem für seinen genreübergreifenden Neo-Pop-Stil und seine modernen Interpretationen klassischer Zeichenkunst. Rückbezüge auf die üppige Kultur des Barock und Rokoko charakterisieren sein Werk. Die kraftvolle Buntheit seiner Bildwelten knüpft an die Bildsprache von Werbeszenarien ebenso an wie an die Kunst der Comic-Zeichner. Nach einer 25-jährigen Karriere als Creative Director für Werbe- und Animationsfilm widmet sich der Maestro seit 2000 hauptsächlich der

Schaffung eigener Kunstwerke. Erfolgreiche Galerie- und Museumsausstellungen folgten unter anderem in Portofino, Buenos Aires, Hongkong, St. Moritz, Miami, Mailand, München, Hamburg, Berlin, Augsburg und Venedig.

The Italian artist Mauro Bergonzoli is best known for his genre-crossing neo-pop style and modern interpretations of classical drawing art. References back to the voluptuous culture of the Baroque and Rococo characterise his work. The powerful colour explosion of his visual world is linked to the visual language of advertising scenes as well as to the art of comic artists. After 25 years of career as creative director for advertising and animation films, the maestro dedicates himself exclusively to creating his own artwork since 2000. Successful exhibitions in museums and galleries followed in Portofino, Buenos Aires, Hong

Kong, St. Moritz, Miami, Milan, Munich, Hamburg, Berlin, Augsburg and Venice.

L'artiste italien Mauro Bergonzoli est surtout connu pour son style néo-pop qui transcende les genres et ses interprétations modernes de l'art du dessin classique. Son œuvre se caractérise par des références à la culture luxuriante du baroque et du rococo. Les couleurs puissantes de ses univers visuels se rattachent autant au langage visuel des scènes publicitaires qu'à l'art des dessinateurs de bandes dessinées. Après une carrière de 25 ans en tant que directeur créatif dans des films publicitaires et d'animation, le maestro se consacre depuis l'an 2000 exclusivement à la création de ses propres œuvres d'art. Des expositions réussies dans des galeries et des musées se sont succédées, notamment à Portofino, Buenos Aires, Hong Kong, St. Moritz, Miami, Milan, Munich, Hamburg, Berlin, Augsburg et Venise.



Mauro Bergonzoli



Magic Bunnies Gold

Vase
20 cm
24.005950.0.288.11 • VE1
67-180-09-1



Magic Bunny Explosion

Vase
30 cm
24.009950.0.288.11 • VE1
67-180-10-1



Magic Bunny Explosion

Schale • Dish • Plat
30 x 30 cm
24.007450.0.288.1 • VE1
67-180-12-1





MAURO BERGONZOLI

NEO POP ART





999

LTD.
EDT.

One Million

Schale • Dish • Plat
24 x 12 cm
24.004950.0.288.1 • VE 1
67-180-16-1



4 005169 371424

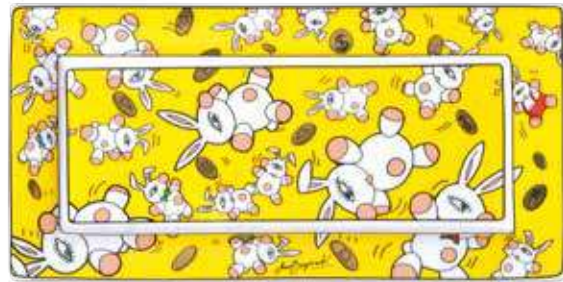

Magic Bunnies Gold

Schale • Dish • Plat
24 x 12 cm
24.002500.0.288.1 • VE 1
67-180-11-1



4 005169 371035

Magic Bunny

Figur • Figurine
Objet décoratif
29,5 cm
24.024950.0.288.1 • VE 1
67-180-06-1



4 005169 366772



999

LTD.
EDT.

Vorder- und Rückansicht
Front and back view
Recto/Verso



MAURO BERGONZOLI



Magic Bunny Explosion
Espressotasse • Espresso cup • Tasse à expresso
7,5 cm • 0,1l
24.001750.0.288.1 • VE 2
67-180-03-1



Magic Bunnies Gold
Espressotasse • Espresso cup • Tasse à expresso
7,5 cm • 0,1l
24.001750.0.288.1 • VE 2
67-180-04-1



Magic Bunny Explosion
Künstlertasse • Mug • Tasse
12 cm • 0,4l
24.002250.0.288.1 • VE 1
67-180-01-1



Magic Bunnies Gold
Künstlertasse • Mug • Tasse
12 cm • 0,4l
24.002250.0.288.1 • VE 1
67-180-02-1



W.T.F. *
Schlüsselanhänger
Keychain • Porte-clés
ø 5 cm
24.000500.0.288.1 • VE 10
67-180-14-1



I Love it! *
Schlüsselanhänger
Keychain • Porte-clés
ø 5 cm
24.000500.0.288.1 • VE 10
67-180-13-1



OMG! *
Schlüsselanhänger
Keychain • Porte-clés
ø 5 cm
24.000500.0.288.1 • VE 10
67-180-15-1



*Verpackung als Display nutzbar • Packaging can be used as a Display • L'emballage peut être utilisé comme présentoir

G mit Echthgoldauflage
with real gold decor
avec décor or véritable

K Kunststoff
Plastic
Plastique

ST Stoff, synthetisch
Fabric, synthetic
Tissu, synthétique

M Metall
Metal
Métal



Magic Bunny Explosion

Einkaufstasche • Shopping Bag

Sac de courses

37 x 12 x 33,5 cm

24.000250.0.288.1 • VE10

67-180-07-1

K



4 005169 366789

mit Innentasche

with inner compartment

avec compartiment intérieur



Magic Bunny Explosion

Stockschild mit Upside-Down-Öffnung

Umbrella with upside down opening

Parapluie à ouverture inversée

80 cm x Ø 108 cm

24.002000.0.288.1 • VE2

67-180-05-1

ST K M



4 005169 366765



JAMES RIZZI

NEW YORK

James Rizzi war ein Pop Art Künstler der besonderen Art. Wie kein anderer verstand er es, die Grenze zwischen Kunst und Alltag zu überwinden, indem er Alltagsgegenständen seinen künstlerischen Stempel aufdrückte. Nicht zuletzt dadurch wurde er zu einem der populärsten Künstler unserer Zeit.

James Rizzi was a pop artist of a different kind. Like no other he knew how to transcend the border between art and daily life by transferring his signature style to everyday objects. Not least because of this he became one of the most popular artists of our time.

James Rizzi était un artiste de pop art exceptionnel. Il faisait preuve d'un talent unique pour abolir les frontières entre l'art et le quotidien en marquant de son empreinte les objets ordinaires. C'est notamment pour cette raison qu'il est devenu l'un des artistes les plus populaires de notre époque.

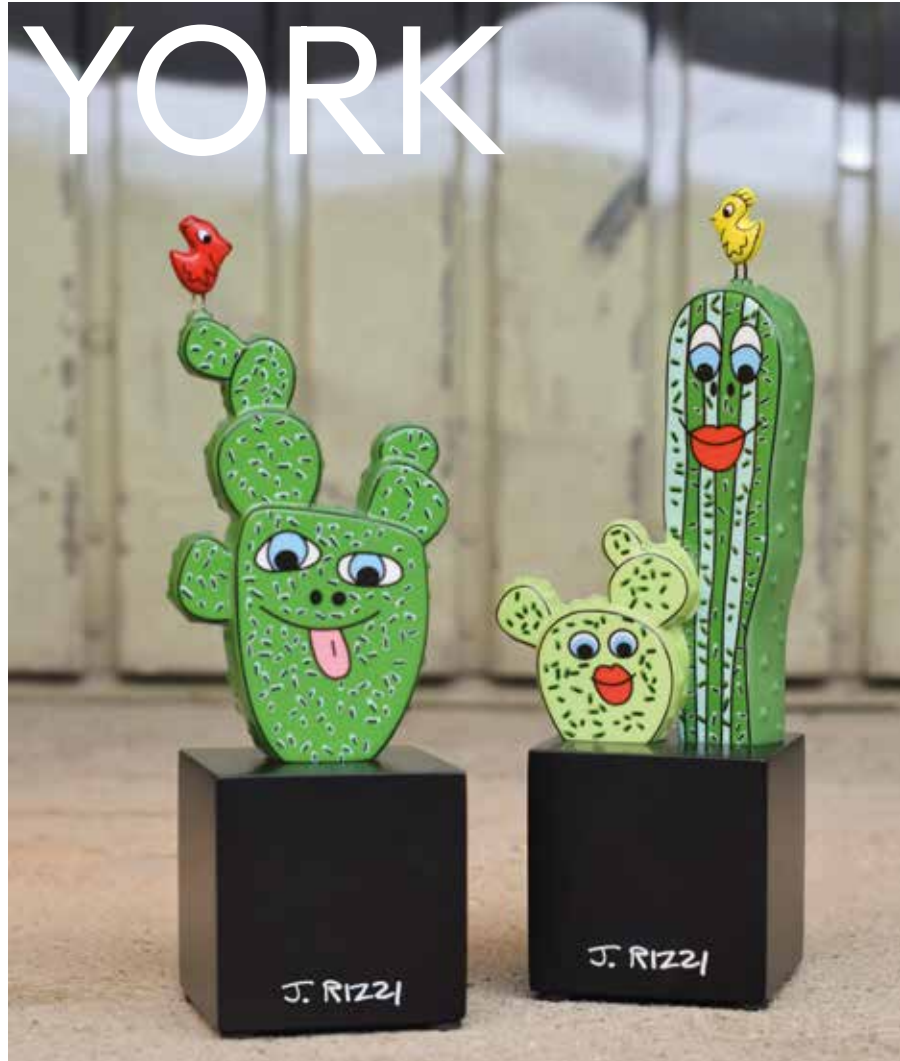

Prickly Pair

Figur • Figurine • Objet décoratif
23 cm
25.005950.0.907.4 • VE1
26-103-47-1

NEW P MDF



4 005169 371899



A Cactus in Texas

Figur • Figurine • Objet décoratif
22 cm
25.005450.0.907.4 • VE1
26-103-48-1

NEW P MDF



4 005169 371905



Desert Life

Figur • Figurine • Objet décoratif
21 cm
23.004950.0.907.1 • VE1
26-103-21-1

P MDF



4 005169 362163

My New York City Sunset

Wanduhr • Clock • Horloge

ø 31 cm

22.007450.0.907.1 • VE1

26-103-17-1



4 005169 359903



Video

JAMES RIZZI

Desert Life

Vase

24 cm

23.004950.0.907.1 • VE1

26-103-22-1



4 005169 362170



The Big Apple is Big on Liberty

Vase

28 cm

23.007450.0.907.1 • VE1

26-103-23-1



4 005169 362187





JAMES RIZZI

My New York City
The City that Never Sleeps

Figur • Figurine • Objet décoratif
70 cm
20.087500.0.9071 • VE 1
26-102-50-1

P MDF Z



4 005169 336188



499
LTD.
EDT.

The Big Apple is Big on Liberty

Figur • Figurine • Objet décoratif
54 cm
23.049950.0.9071 • VE 1
26-103-18-1

P MDF Z



4 005169 362132

199
LTD.
EDT.

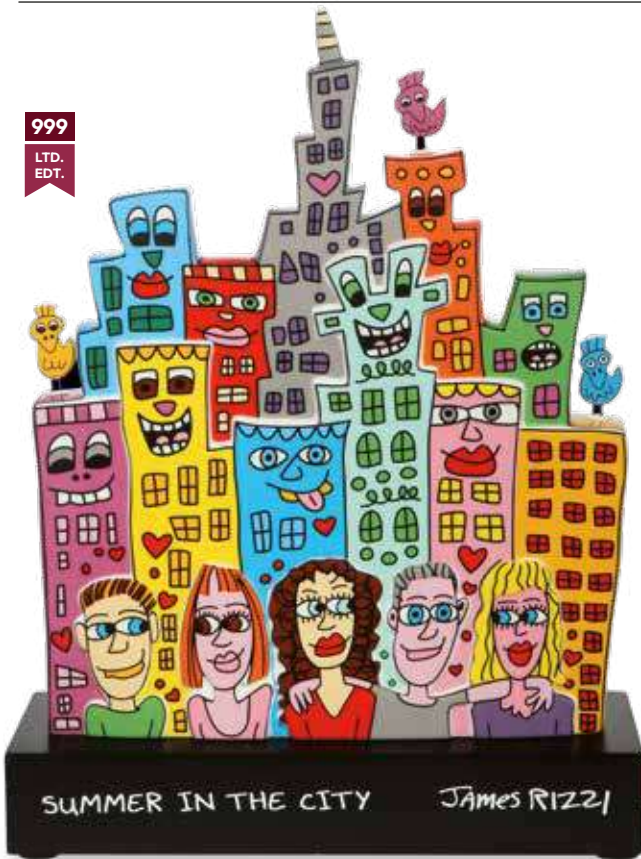

999
LTD.
EDT.

Summer in the City

Figur • Figurine • Objet décoratif
38,5 cm
22.024950.0.907.7 • VE1
26-102-82-1

P MDF Z



Summer in the City

Figur • Figurine • Objet décoratif
22,5 cm
24.012450.0.907.1 • VE1
26-103-37-1

P MDF

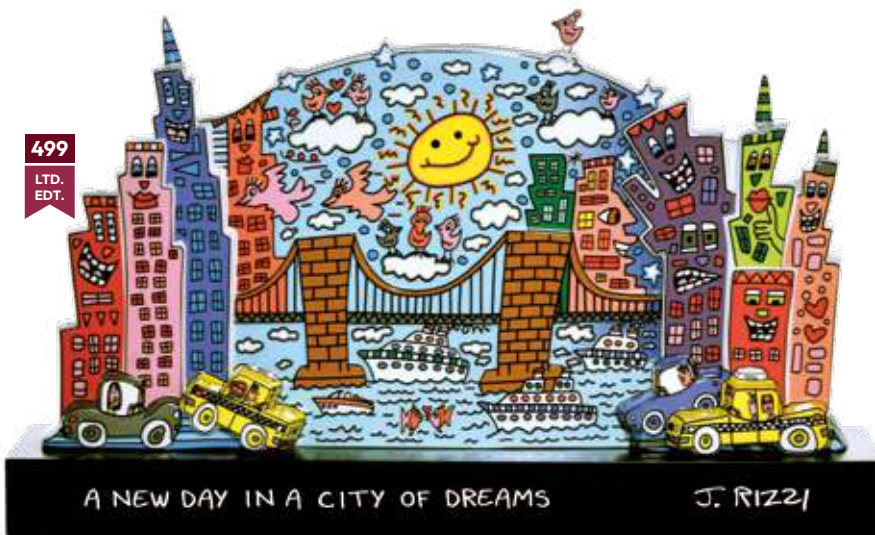

499
LTD.
EDT.

**A New Day
in a City of Dreams**

Figur • Figurine • Objet décoratif
28,5 cm
24.029950.0.907.7 • VE1
26-103-36-1

P MDF Z





Living in the USA

Figur • Figurine • Objet décoratif
15 x 19 cm
22.007450.0.907.7 • VE 1
26-103-08-1

MDF



JAMES RIZZI



Heart Times in the City

Figur • Figurine • Objet décoratif
23 cm
21.009950.0.907.7 • VE 1
26-102-83-1

MDF



Vorder- und Rückansicht
Front and back view
Recto/Verso



Coo Coo Bird

Figur • Figurine • Objet décoratif
27,5 cm
23.004250.0.907.7 • VE 1
26-103-20-1

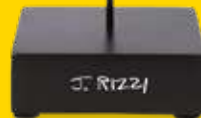

Snow Bird

Figur • Figurine • Objet décoratif
27,5 cm
23.004250.0.907.7 • VE 1
26-103-19-1



Love in the Heart of the City

Figur • Figurine • Objet décoratif
27,5 cm
18.004950.0.907.1 • VE 1
26-101-54-1



Give Peace a Chance

Vase
20 cm
21.005950.0.907.7 • VE 1
26-102-85-1



KÜNSTLERTASSEN • MUGS • TASSES

The Romance of the Sea

19,5 x 13,5 x 12 cm • 0,4 l
23.002250.0.907.1 • VE1
26-102-75-1



4 005169 350153



Desert Life

19,5 x 13,5 x 12 cm • 0,4 l
23.002250.0.907.1 • VE1
26-102-78-1



4 005169 350184



Summer in the City

19,5 x 13,5 x 12 cm • 0,4 l
23.002250.0.907.1 • VE1
26-102-79-1



4 005169 350191

Give Peace a Chance

19,5 x 13,5 x 12 cm • 0,4 l
23.002250.0.907.1 • VE1
26-102-80-1



4 005169 350207

ESPRESSOTASSEN • ESPRESSO CUPS • TASSES À EXPRESSO



The Romance of the Sea

6,5 cm • 0,1 l
23.001750.0.907.1 • VE2
26-102-69-1



4 005169 350092

Desert Life

6,5 cm • 0,1 l
23.001750.0.907.1 • VE2
26-102-72-1



4 005169 350122

Summer in the City

6,5 cm • 0,1 l
23.001750.0.907.1 • VE2
26-102-73-1



4 005169 350139

Give Peace a Chance

6,5 cm • 0,1 l
23.001750.0.907.1 • VE2
26-102-74-1



4 005169 350146

My New York City Day

Tea for One
15,5 cm • 0,35 l
24.002750.0.907.7 • VE 1
26-103-35-1



4 005169 366581



JAMES RIZZI

MILCHKAFFEE TASSEN
MILK COFFEE CUPS
TASSES À CAFÉ AU LAIT



My New York City Sunset

8,5 cm x ø 19 cm • 0,5 l
24.002500.0.907.1 • VE 1
26-103-31-1



4 005169 366543

TEE- & CAPPUCCINOTASSEN
TEA & CAPPUCCINO CUPS
TASSE À THÉ & CAPPUCCINO



My New York City Sunset

7 cm • ø 15 cm • 0,25 l
20.001750.0.907.1 • VE 1
26-102-61-1



4 005169 339288

SCHALEN
BOWLS
COUPES



My New York City Day

7 cm x ø 15 cm
22.001250.0.907.1 • VE 2
26-103-13-1



4 005169 357503



My New York City Day

8,5 cm x ø 19 cm • 0,5 l
24.002500.0.907.1 • VE 1
26-103-32-1



4 005169 366550



My New York City Day

7 cm • ø 15 cm • 0,25 l
20.001750.0.907.1 • VE 1
26-102-62-1



4 005169 339295



My New York City Night

7 cm x ø 15 cm
22.001250.0.907.1 • VE 2
26-103-14-1



4 005169 357510



JAMES RIZZI



My New York City

Eierbecher Set • Set of Egg Cups

Set des Coquetiers

25.001375.0.907.4 • VE2

26-103-52-1

NEW



4 005169 373244

My New York City

Butterdose • Butter Dish • Beurrier

14,5 x 12 x 8 cm

25.002500.0.907.4 • VE1

26-103-51-1

NEW



4 005169 373015

My New York City

Teekanne • Tea Pot • Thière

mit Stövchen • with warmer • avec réchaud

19 cm • 1,2 l

25.007450.0.907.4 • VE1

26-102-68-1

NEW



4 005169 341342



All Roads Lead to Bremen

Künstlertasse • Mug • Tasse
19,5 x 13,5 x 12 cm • 0,4 l
24.002250.0.907.1 • VE1
26-103-43-1



**Remember those
Cool Coal Days**

Künstlertasse • Mug • Tasse
19,5 x 13,5 x 12 cm • 0,4 l
24.002250.0.907.1 • VE1
26-103-44-1



My New York City Sunset

Künstlertasse mit Deckel
Mug with lid
Tasse avec couvercle
15 cm • 0,5 l
21.002000.0.907.7 • VE1
26-103-06-1



Not Getting Around the Traffic

Teetasse mit Deckel und Sieb
Teacup with lid and strainer
Tasse pour thé avec couvercle et passe-thé
14 cm • 0,45 l
22.002125.0.907.7 • VE1
26-103-16-1



Birds on a Love Wire

Teetasse mit Deckel und Sieb
Teacup with lid and strainer
Tasse pour thé avec couvercle et passe-thé
14 cm • 0,45 l
22.002125.0.907.7 • VE1
26-103-15-1





JAMES RIZZI



My New York City Sunset

Magnettafel • Magnetboard • Tableau magnétique
 mit 2 Magneten • with 2 magnets • 75 x 25 cm
 24.004450.0.907.1 • VE 1
 26-103-40-1



4 005169 367410

The Romance of the Sea

Teelicht • Tealight • Photophore
 mit Teelicht • with tealight
 avec bougie
 9,5 cm
 24.001000.0.907.1 • VE 2
 26-103-45-1



4 005169 371127



Summer in the City

Teelicht • Tealight • Photophore
 mit Teelicht • with tealight
 avec bougie
 9,5 cm
 24.001000.0.907.1 • VE 2
 26-103-46-1



4 005169 371134



KÜNSTLERDOSE • BOX • BOÎTE



Summer in the City

7,5 x 7,5 x 11 cm • 0,6 l
 24.000500.0.907.7 • VE 4
 26-103-41-1



4 005169 368592



Peace of Love

7,5 x 7,5 x 11 cm • 0,6 l
 24.000500.0.907.7 • VE 4
 26-103-42-1



4 005169 368608



The Romance of the Sea

7,5 x 7,5 x 11 cm • 0,6 l
 23.000500.0.907.7 • VE 4
 26-103-24-1



4 005169 362194



Desert Life

7,5 x 7,5 x 11 cm • 0,6 l
 23.000500.0.907.7 • VE 4
 26-103-25-1



4 005169 362200

SCHLÜSSELANHÄNGER • KEYCHAIN • PORTE-CLÉS



Unexpected Company

6,5 x 5 cm
23.000500.0.907.7 • VE 6
26-103-28-1



Peace Heart

5,5 x 5 cm
23.000500.0.907.7 • VE 6
26-103-26-1



Rizzi Bird

6 x 5 cm
23.000500.0.907.7 • VE 6
26-103-27-1



A Funny Sunny Day

5,5 x 4 cm
23.000500.0.907.7 • VE 6
26-103-29-1



Yellow Cab

Schlüsselbrett • Key board
Tableau des clés
13,5 x 8,5 cm
24.001250.0.907.7 • VE 1
26-103-39-1



Fun Ride

Schlüsselbrett • Key board
Tableau des clés
12,5 x 7,5 cm
24.001250.0.907.7 • VE 1
26-103-38-1



Schlüsselanhänger

Keychains • Porte-clés
Display 34 x 12 x 13 cm
4 x 6 Stck./Pcs.
23.011940.0.907.7 • VE 1
26-103-30-1





JAMES RIZZI



My New York City

Einkaufstasche | Shopping Bag
Sac à courses
37 x 12 x 33,5 cm
25.000250.0.907.7 • VE 10
26-103-49-1

NEW **K** **M**



My New York City

Stockschirm mit Upside-Down-Öffnung
Umbrella with upside down opening
Parapluie à ouverture inversée
80 cm x Ø 108 cm
25.002000.0.907.4 • VE 2
26-103-50-1

NEW **K** **M** **ST**



**Not Getting
Around the Traffic**

37 x 12 x 33,5 cm
19.000250.0.907.1 • VE 10
26-102-49-1

K



Desert Life

37 x 12 x 33,5 cm
24.000250.0.907.1 • VE 10
26-103-33-1

K



My New York City Sunset

37 x 12 x 33,5 cm
21.000250.0.907.1 • VE 10
26-102-81-1

K



STOCKSCHIRME MIT UPSIDE-DOWN-ÖFFNUNG
UMBRELLAS OPEN WITH UPSIDE DOWN
PARAPLUIE À OUVERTURE INVERSÉE



Video



My New York City Sunset

80 cm x Ø108 cm
 20.002000.0.907.1 • VE 2
 26-102-53-1



4 005169 339202



Desert Life

80 cm x Ø108 cm
 24.002000.0.907.1 • VE 2
 26-103-34-1



4 005169 366574

Der Upside-Down-Schirm ist eine innovative Variante des herkömmlichen Regenschirms. Der zweilagig bespannte Schirm schiebt beim Öffnen den kunstvoll bedruckten Stoff von außen nach innen.

Durch diese Technik wird die nasse Seite beim Schließen wieder nach innen gezogen und schützt somit besser vor lästigen Tropfen auf Kleidung und Innenräumen. Darüber hinaus macht die stoffliche Doppelbespannung den Schirm robuster und vertreibt die Tristesse des Regens durch kunstvolle Motive an deinem eigenen „Schirmhimmel“.

The upside-down umbrella is an innovative version of the conventional umbrella. When opened, the double-layered umbrella pushes the art printed fabric from the outside to the inside. This technique makes sure that the wet side is pulled back inwards when the umbrella is closed, providing better protection against annoying drops on clothing and interiors. In addition, the double fabric covering makes the umbrella more robust and dispels the dreariness of the rain with artistic motifs on your own “umbrella sky”.

Le parapluie inversé est une variante innovante du parapluie traditionnel. Lorsqu'il s'ouvre, le parapluie recouvert de deux couches fait glisser le tissu imprimé de l'extérieur vers l'intérieur. Grâce à cette technique, le côté mouillé est ramené vers l'intérieur lors de la fermeture et protège ainsi mieux des gouttes gênantes sur les vêtements et à l'intérieur. En outre, la double toile rend le parapluie plus robuste et chasse la tristesse de la pluie grâce à des motifs artistiques sur ton propre « ciel de parapluie ».

PRÄSENTATIONSVORSCHLAG SUGGESTION FOR DECORATION PROPOSITION DE DÉCORATION





Einkaufstasche

Shopping Bag
Sac à courses
37 x 12 x 33,5 cm
25.000200.0.981.4
VE 25
96-968-89-1

K



4 005169 374555

mit Innentasche
with inner compartment
avec compartiment intérieur



Plastikeinsatz für Bodenvase

Plastic insert for floor vase
Insert plastique pour grand vase
32 cm x ø 18 cm
Für Vasen • For vases • Pour les vases
41 + 55 cm
19.000998.0.983.1 • VE 1
69-989-51-1

K



4 005169 336119



Endverbraucherflyer

Goebel Porzellan - D
2025
ohne Preise
15 x 15 cm
96-969-03-1 • VE 20



4 005169 375323

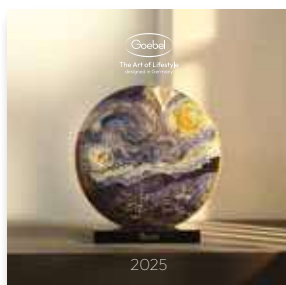

Consumer Flyer Dépliant consommateur

Goebel Porzellan - EN/F
2025
without price list • sans prix
15 x 15 cm
96-969-04-1 • VE 20



4 005169 375330



Einkaufstasche

Shopping Bag • Sac à courses
37 x 12 x 33,5 cm
18.000100.0.981.1 • VE 25
96-963-17-1

K



4 005169 319389

KÜNSTLERDOSE

BOX • BOÎTE



- Für ca. 200 g Tee (je nach Sorte)
- Dose aus Weißblech
- Praktischer Stülpdeckel
- Lebensmittelecht
- Schützt den Inhalt vor äußeren Einflüssen wie Feuchtigkeit
- Bequemes Öffnen, Nachfüllen und Verschließen
- For approximately 200 g of tea (depending on variety)
- Tinplate
- Convenient slip lid
- Food-safe
- Protects the contents from external influences such as moisture
- Easy opening, refilling and closing
- Pour environ 200 g de thé (selon la variété)
- Fer blanc
- Couverture cloche pratique
- Convient pour aliments
- Protège le contenu contre les influences extérieures telles que l'humidité
- Facile à ouvrir, à rajouter et à fermer

KÜNSTLERTASSE MIT DECKEL

MUG WITH LID • TASSES AVEC COUVERCLE



- Angenehm leichtes Fine Bone China
- Umweltfreundlich und wiederverwendbar
- Kunststoffdeckel mit verschließbarer Trinköffnung
- Passend für alle gängigen Getränkehalter
- Dekore ohne Echtgold- oder Platinauflage sind spülmaschinengeeignet
- Made of lightweight Fine Bone China
- Eco-friendly and reusable
- With tight-fitting plastic lid
- Fits all common cup holders
- Decors without real gold or platinum plating are dishwasher-safe
- En Fine Bone China léger
- Respectueux de l'environnement et réutilisable
- Avec couvercle en plastique fermant hermétiquement
- Convient à tous les porte-gobelets courants
- Les décors sans revêtement en or véritable ou en platine sont lavables au lave-vaisselle

WANDUHR / PORZELLAN

WALLCLOCK / PORCELAIN • HORLOGE MURALE / PORCELAINE



- Hochwertiges, geräuscharmes Uhrwerk, made in Germany
- Stabile, geprägte Zeiger
- Batterietyp AA verwenden
- Batterie nicht im Lieferumfang enthalten
- High-quality, noiseless clockwork, made in Germany
- Sturdy, embossed hands
- Requires AA battery
- Battery not included
- Mouvement silencieux, de haute qualité, fabriqué en Allemagne
- Aiguilles gaufrées et stables
- Nécessite pile AA
- Pile non incluse

WANDUHR / HOLZ

WALLCLOCK / WOOD • HORLOGE MURALE / BOIS



- Hochwertiges, geräuscharmes Uhrwerk
- Stabile, geprägte Zeiger
- Batterietyp AA verwenden
- Batterie nicht im Lieferumfang enthalten
- High-quality, noiseless clockwork
- Sturdy, embossed hands
- Requires AA battery
- Battery not included
- Mouvement silencieux, de haute qualité
- Aiguilles gaufrées et stables
- Nécessite pile AA
- Pile non incluse

BRILLENETUI

SPECTACLE CASE • ÉTUI À LUNETTES



- Stabile, mit Stoff bezogene Hartschale
- Angenehme Haptik
- Sicherer Klickverschluss
- Weiche Filzauskleidung
- Für alle gängigen Brillengrößen geeignet
- Inklusive Mikrofaser-Reinigungstuch
14,5 x 17,5 cm
- Lieferung in attraktivem Geschenkkarton
- Solid hard-shell case with fabric cover
- Pleasant touch
- Strong, secure metal hinge
- Lined with soft felt
- For all common sizes of glasses
- With microfiber cleaning cloth
14,5 x 17,5 cm
- Attractive gift box
- Coque solide, recouverte de tissu
- Toucher agréable
- Fermeture à clic sécurisée
- Revêtement en feutre doux
- Pour toutes tailles de lunettes courantes
- Avec chiffon en microfibres
14,5 x 17,5 cm
- Emballage cadeau

TEA FOR ONE



- Set bestehend aus Teekanne, Tasse und Untertasse
- Fassungsvermögen: Teekanne 0,35 l, Tasse 0,25 l
- Angenehm leichtes Fine Bone China
- Dekore ohne Echtgold- oder Platinauflage sind spülmaschinengeeignet
- Set consisting of teapot, cup and saucer
- Teapot holds 0.35 l, cup 0.25 l
- Lightweight Fine Bone China
- Decors without real gold or platinum plating are dishwasher-safe
- Composé d'une théière, d'une tasse et d'une soucoupe
- Capacité de la théière 0,35 l et de la tasse 0,25
- En Fine Bone China léger
- Lavable au lave-vaisselle
- Les décors sans revêtement en or véritable ou en platine sont lavables au lave-vaisselle

TEETASSE MIT DECKEL UND SIEB

TEACUP WITH LID AND STRAINER • TASSE POUR THÉ AVEC COUVERCLE ET PASSE-THÉ



- Aus angenehm leichtem Fine Bone China
- Deckel kann als Ablage für Sieb, Teebeutel oder Gebäck verwendet werden
- Sieb aus rostfreiem Stahl, fein perforiert, spülmaschinengeeignet
- Dekore ohne Echtgold- oder Platinauflage sind spülmaschinengeeignet
- Made from lightweight Fine Bone China
- Lid can be used to hold strainer, teabag or pastries
- Stainless-steel sieve with fine perforation dishwasher-safe
- Decors without real gold or platinum plating are dishwasher-safe
- En Fine Bone China léger
- Le couvercle peut également être utilisé comme plateau pour la passoire, les sachets de thé ou des biscuits
- Passoire en acier inoxydable, finement perforée - lave-vaisselle
- Les décors sans revêtement en or véritable ou en platine sont lavables au lave-vaisselle

UPSIDE-DOWN SCHIRM

UPSIDE-DOWN UMBRELLA • PARAPLUIE AVEC OUVERTURE À L'ENVERS



- Material: Stoff, synthetisch
- Stockschild mit Upside/Down Öffnung
- Zweilagig bespannt und sturmfest
- Nasse Seite klappt nach innen
- Freistehend
- Material: Textile, synthetic
- Stick umbrella with upside/down opening
- Double layered and storm proof
- Wet side folds inwards
- Freestanding
- Matière: Textile synthétique
- Parapluie-canne avec ouverture à l'envers
- Double couche et résistant aux tempêtes
- Le côté humide se replie vers l'intérieur
- Stable, ne tombe pas



The Art of Lifestyle
designed in Germany



join our social network



96-968-94-1



© Goebel • Goebel Porzellan GmbH
Auwaldstraße 8 • 96231 Bad Staffelstein
Tel.: 09563 / 92-0 • goebel@goebel.de
www.goebel.de